

Specification

Frequency Range	1550MHz~1600MHz
V. S. W. R	≤2.0
Impedance	50Ω
Gain	1.85dBi
Azimuth	Omni-directional
Polarization	Linear
Impedance	50 Ω
Azimuth Beam width	Omni-directional

Dimension (mm)

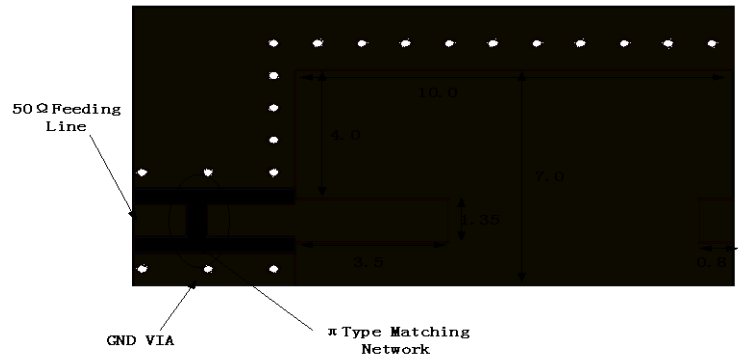
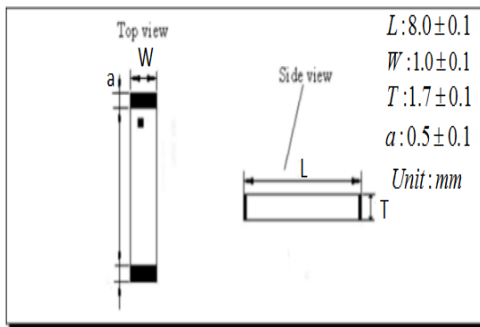

Performance

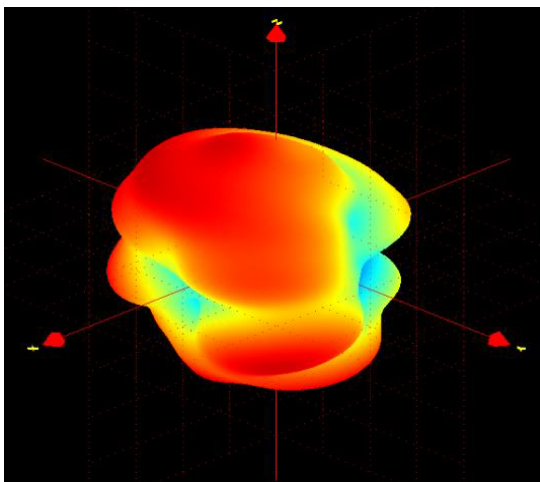

Test Graph

